

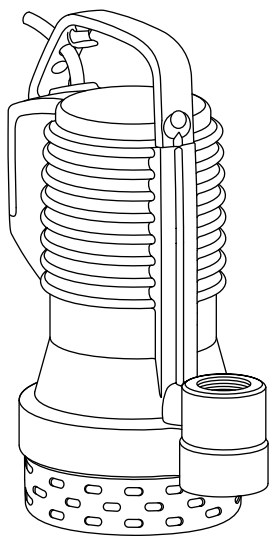

water solutions

blue



blue
PROFESSIONAL

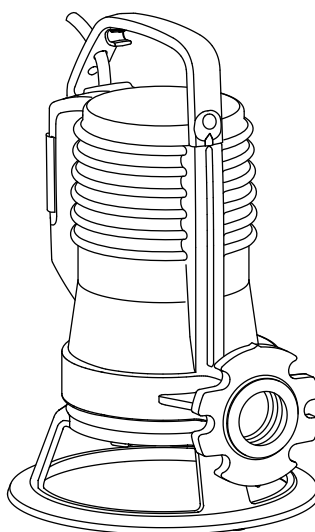



EN

*The images are indicative only and may not match the actual product.
Details given here may differ from the actual product.
Zenit reserves the right to modify the product without prior warning.
For more information, consult the website www.zenit.com.*

The complete operator's manual and product technical information are available on the www.zenit.com website

Before installing and using the pump, read the instructions given below carefully. Check that the box and its contents are in perfect condition and stop the installation in the event that any defects or anomalies are found, then inform the supplier.

1. CONDITIONS OF USE

The **DRBlue** and **APBlue** models are designed for the evacuation of clear water or dirty water containing small solid bodies.

In the **DRBlue** versions the intake strainer can be removed by skilled technical staff to enable fluid intake from up to the last few millimetres from the bottom.

The motor can be allowed to run uncovered very briefly.

The **DGBlue** model guarantees a clear passage for solids of up to 50 mm and is suitable for the treatment of dirty water.

The **GRBlue** model can be used for sewage containing fibres which can be shredded using an intake shredding system.

WARNING Pollution of the liquid could occur due to leakage of lubricants.

2. INSTALLATION

The pump must operate completely submerged in the liquid to ensure that the motor is cooled sufficiently (**Fig.1 page 27**).

If the pump is installed inside a shaft, this must be large enough to allow the floating switch, if installed, to move freely. The manufacturer recommends the use of shafts which are no smaller than 500mm x 500mm x 500mm.

WARNING Check that the submersible pump has been primed. In some cases, an air bubble may form in the upper part of the pump body, which prevents liquid pumping.

WARNING Before installing and/or starting a DRBlue 40/50 or DGBlue 40/50 pump after a long period out of use, check that the shaft turns freely by proceeding as follows (**Fig. 2 page 27**):

1. take the precautions detailed in the "Safety warnings" manual;
2. turn the pump upside down;
3. (for DRBlue only) insert a Torx screwdriver in the hole in the centre of the intake strainer;
4. engage the Torx screwdriver with the impeller fixing screw;
5. turn the screwdriver clockwise and anti-clockwise 3-4 times to ensure that the impeller rotates freely.

2.1 Mobile post (Fig. 3 page 27): using a hose union, connect the delivery pipe to a hose with an internal reinforcement coil and a diameter which is the same size as or larger than the electric pump outlet.

2.2 Fixed post (Fig. 4 page 27): connect the electric pump to a metal piping, fitting a non-return valve and an interception gate valve on the said metal piping. This ensures the pump stability is guaranteed by the piping.

The pump can also be connected to polyethylene piping, using the relative union. Secure the hose to the union by means of a metal band clamp.

2.3 With the joining foot (Fig. 5 page 27): Fix the joining foot to the bottom of the tank first, using expansion plugs. Install the delivery pipe with the relative non-return valve and gate valve.

Engage two guidepipes on the joining foot, fixing them in the upper part using the spacer bracket provided by Zenit with the joining foot.

This way, the pump can be lowered supported with a chain or cable hooked around the handle and, thanks to the two guide pipes it will fit perfectly in place on the foot.

3. FLOATING SWITCH

The electric pump can be supplied with a floating switch and its functioning is completely automatic (**Fig. 6 page 27**).

The floating switch has an adjustable stroke to allow regulation of the on and off levels.

Make sure that there is nothing around that could obstruct the movement.

It is important that the cables do not get in each other's way, twisted up or stuck in any jutting parts or grips inside the tank (**Fig. 7 page 27**).

If the pump does not have a start/stop floating switch, one or more start/stop floating switches should be installed inside the tank to control starting and stopping and for any alarms.

In the event of strong turbulence, floating switches should be installed on a rigid rod mounted inside the tank

Make sure that the minimum level does not fall below the pump's upper shield (**Fig. 8 page 27**).

4. ELECTRICAL CONNECTIONS (Figs. 9-10 page 28)

- All operations connected to the mains must be performed by qualified personnel, in compliance with the local regulations.
- The electrical connection of the models without plug must be performed by connecting first the yellow-green to the ground, then the other wires.
- To ensure safety the pump is to be supplied through a residual current device (RCD) having a rated residual operating current not exceeding 30 mA.
- Appliances without plug are intended to be permanently connected to fixed wiring; a switch that ensure the all-pole disconnection incorporated in the fixed

wiring is to be provided. The switch shall be directly connected to the supply terminals and shall have a contact separation in all poles, providing full disconnection under overvoltage category III (4000V).

- The pump motor must be protected from overload by installing in the main control circuit or power line of pump an overload protection (motor protection breaker). The protection must be adequately dimensioned according to the rated pump data.
- The starting current in direct-on-line start can be up to six times higher than the rated current.

WARNING The pump may be fitted with automatically-resetting thermal protection which prevents damage in the event of overheating. Once the pump has cooled own, it restarts automatically.

Before installation, ensure that:

- the power supply line is connected to ground and complies with the relevant legal requirements;
- the power supply cable and the float switch cable (if installed) are not damaged.

5. CHECKING THE IMPELLER ROTATION DIRECTION (three-phase models only)

Before making the three-phase electrical connection, make sure the rotation direction is correct.

To check the rotation direction, proceed as follows:

1. take the precautions detailed in the "Safety warnings" manual;
2. Lay the pump horizontal on one side and leave it free
3. Temporarily connect the yellow-green wire to ground and then connect the power supply wires to the contactor;
4. Make sure there are no people or objects within a radius of at least 1 metre of the pump;
5. Turn on the start switch for a few moments;
6. Watch the impeller as it stops through the intake port and check that it turns anticlockwise.

If the pump is rotating in the wrong direction, invert two of the power supply wires in the contactor and try again.

Once the correct rotation direction has been obtained, MARK the power supply wire connection positions, REMOVE the temporary electrical connections and install the pump in the planned position.

6. WARRANTY

Zenit undertakes to repair or replace the product if failures are due to design, manufacturing and assembly defects and are reported to Zenit during the warranty period.

The warranty does not cover failures due to:

- normal wear and tear;
- improper handling, installation and use;
- use with incorrectly connected control systems;
- work done by unskilled staff;
- use of non-genuine spare parts.

WARNING Any modifications made to the product without the manufacturer's authorisation may cause hazards and lead to a deterioration in performance and loss of warranty cover.

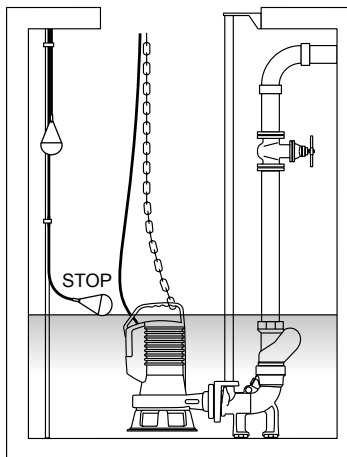
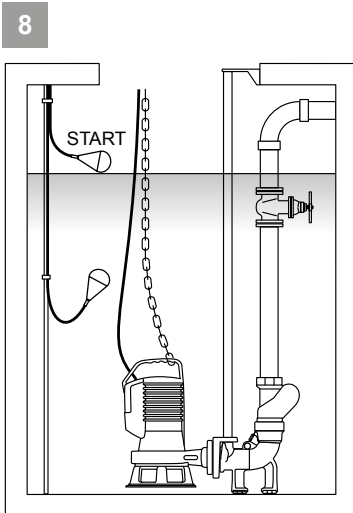
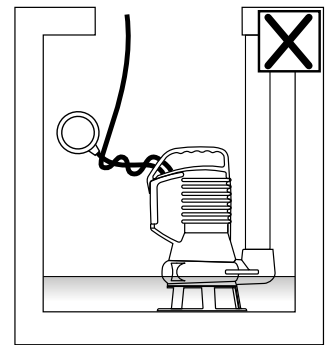
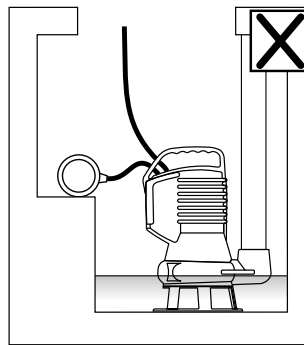
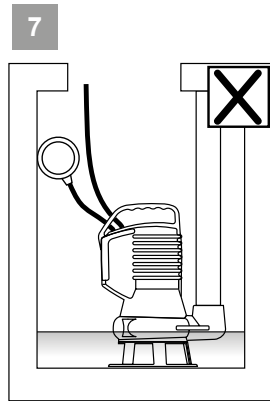
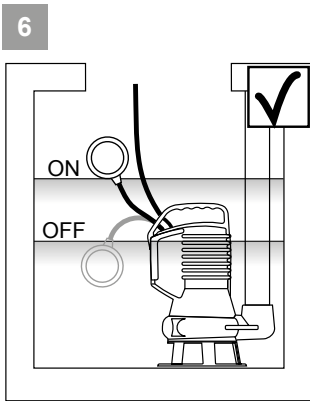
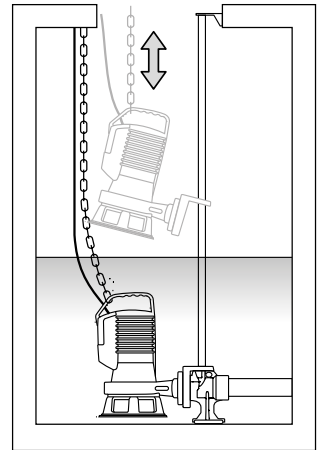
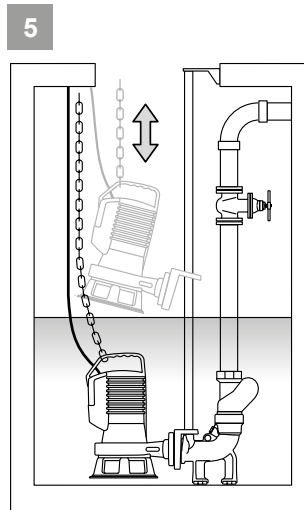
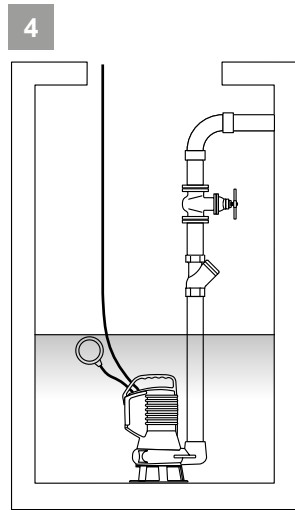
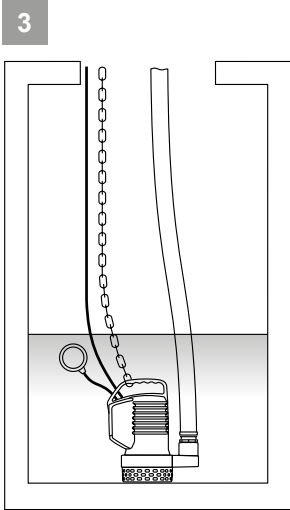
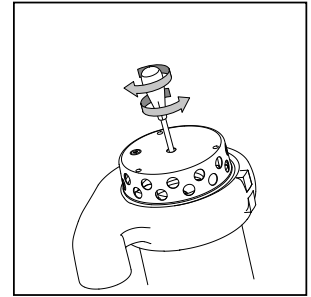
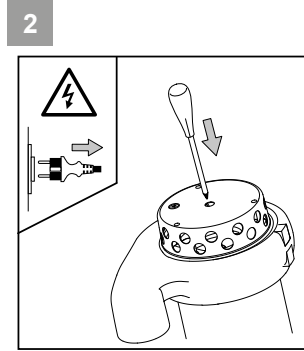
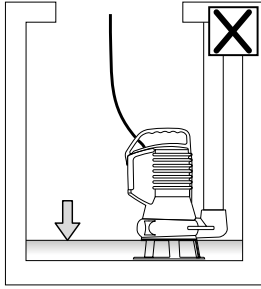
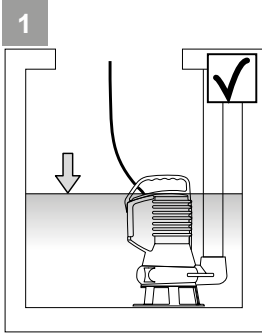

EN

ELECTRICAL CONNECTIONS

EN For electrical connection, refer to the diagram corresponding to the electric pump version indicated on the plate



9 ~1 50/60Hz

TC, TCG

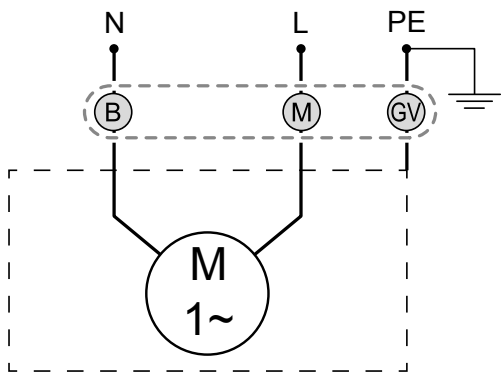

10 ~3 50/60Hz

NAE, TR, TRG

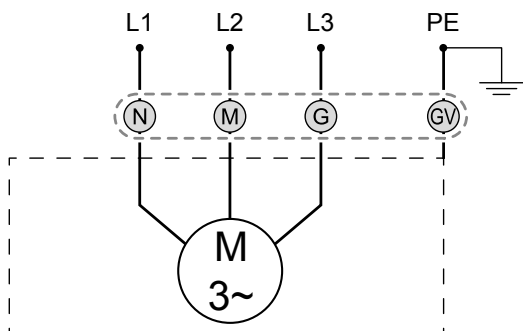

T

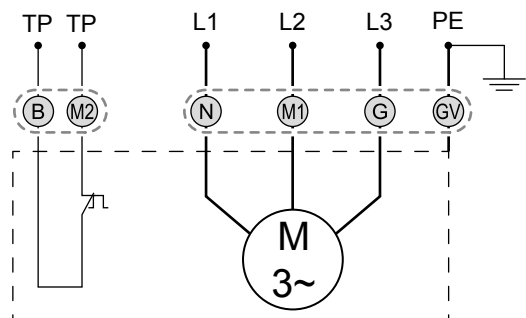



	L - N	L1 - L2 - L3	PE	TP	(N)	(M)	(G)	(B)	(GV)
EN	Single-phase power supply	Three-phase power supply	Ground	Thermal protection	Black	Brown	Grey	Blue	Yellow/Green

EN

PRODUCT IDENTIFICATION

Zenit Italia s.r.l.
via dell'Industria, 11
I-41018 S.Cesario s.P. (MO)
zenit.com

CE

Type **1**

Ver. **2** S/n **3**

Motor **4** ~ Hz **5** Rpm **6**

V **7** A **8** P2 **9** kW

CI **10** IP **11** μ F **12** S1 **20**

Q_{min} **13** l/min H_{max} **14** m

Q_{max} **13** l/min H_{min} **14** m

15 ∇ Kg **16** Class I **18** Tmax=40°C **18**

17 m Y **17** IEC 60034-1 **19**

blue

Zenit Italia s.r.l.
via dell'Industria, 11
I-41018 S.Cesario s.P. (MO)
zenit.com

CE

Type **1**

Ver. **2** S/n **3**

Motor **4** ~ Hz **5** Rpm **6**

V **7** A **8** P2 **9** kW

CI **10** IP **11** μ F **12**

Q_{min} **13** l/min H_{max} **14** m

Q_{max} **13** l/min H_{min} **14** m

15 ∇ Kg **16** Tmax=40°C **18** Class I **18**

17 m Y **17** IEC 60034-1 **19** S1 **20**

blue PRO

EN	
1	Product name
2	Version
3	Serial number
4	Phase Number
5	Frequency
6	Rpm
7	Tension
8	Current
9	Power at Motor Shaft
10	Motor Insulation Class
11	Degree of protection
12	Capacitance of capacitor
13	Min/Max Capacity
14	Min/Max Hydraulic Head
15	Maximum Immersion Depth
16	Weight
17	Model Year
18	Maximum Ambient Temperature
19	Reference standards
20	Operation



EN

DATA LABEL

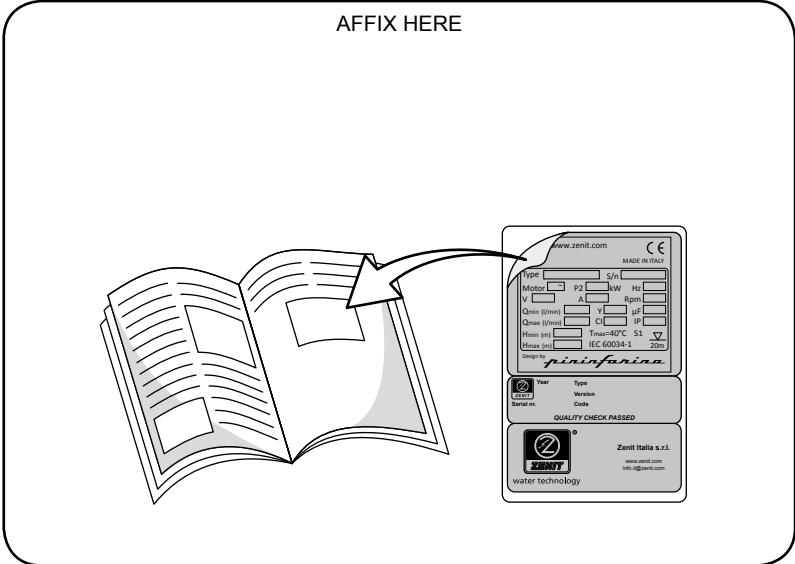



water solutions

zenit.com

Cod. 2727010051310000
Rev. 5 - 01/09/18